

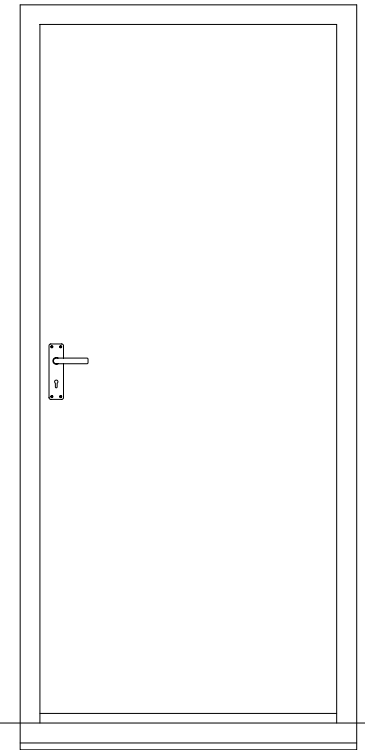

SINGLE DOORS
01487 840885

Door Type Colour Wall Thickness
 Cust Ref Inside Outside Frame mm
 Part Number: 4 0 0 - -

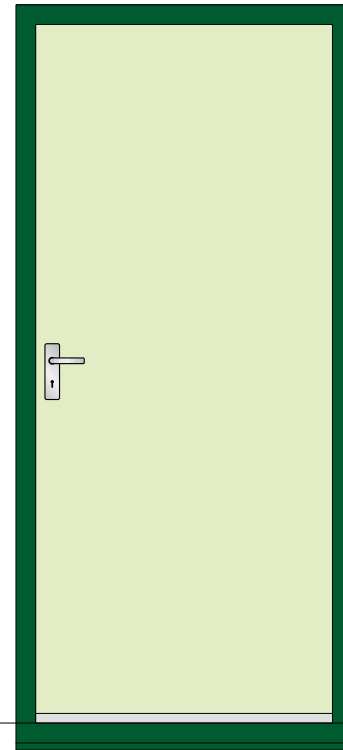
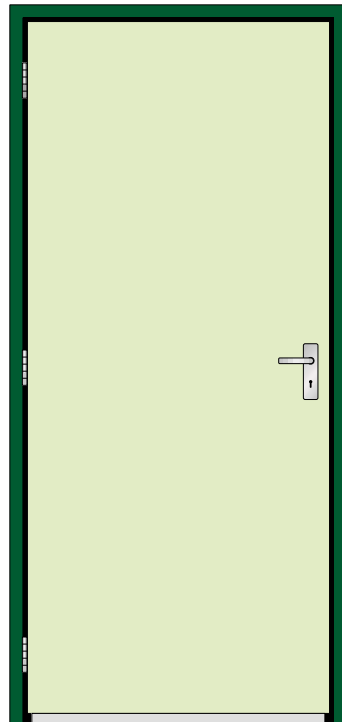
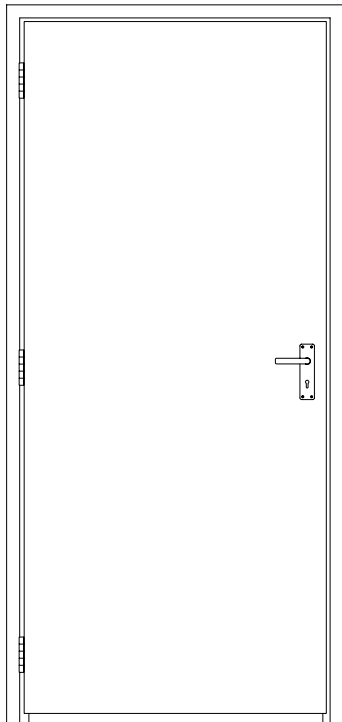

Right Hand Inward Opening - Plain
Inside View

Right Hand Inward Opening - Plain
Outside View

	<input type="checkbox"/>	<input type="checkbox"/>	<input type="checkbox"/>	<input type="checkbox"/>	<input type="checkbox"/>	<input type="checkbox"/>	<input type="checkbox"/>	<input type="checkbox"/>	<input type="checkbox"/>	
Code	A	B	C	D	E	F	G	H	L	M

Other colours available on request
Reference for these colours at the end of the document

Door Type Colour Wall Thickness
 Cust Ref Inside Outside Frame mm
 Part Number: 4 0 1 - -

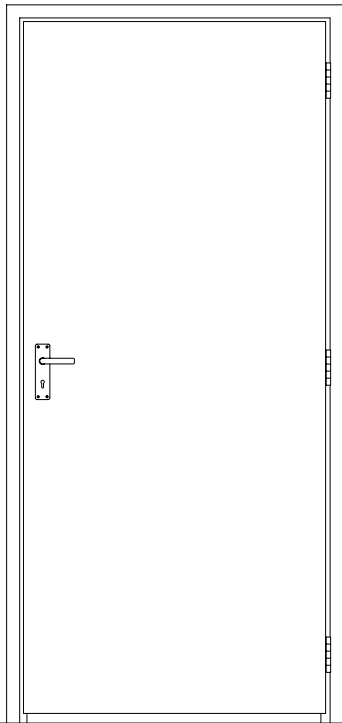

Left Hand Inward Opening - Plain
Inside View

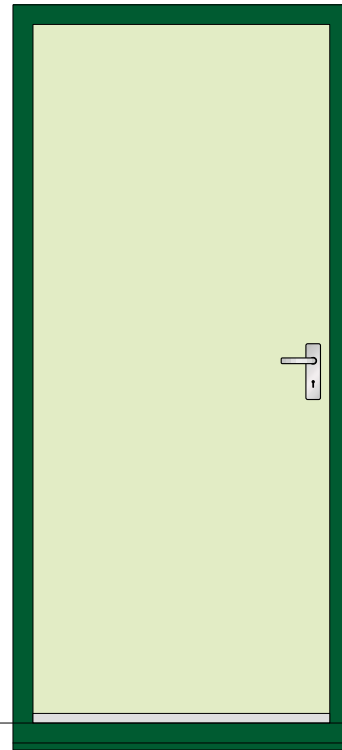
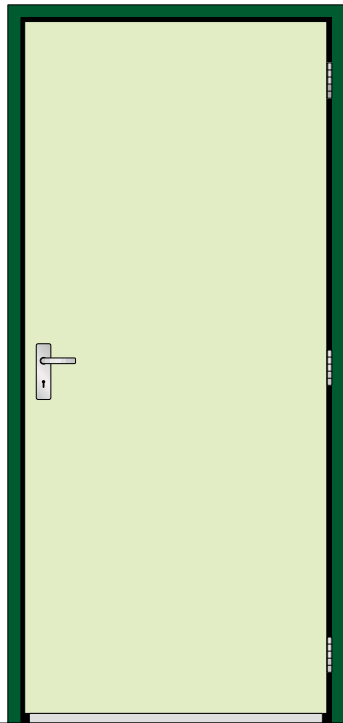

Left Hand Inward Opening - Plain
Outside View

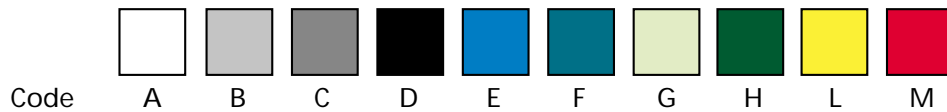
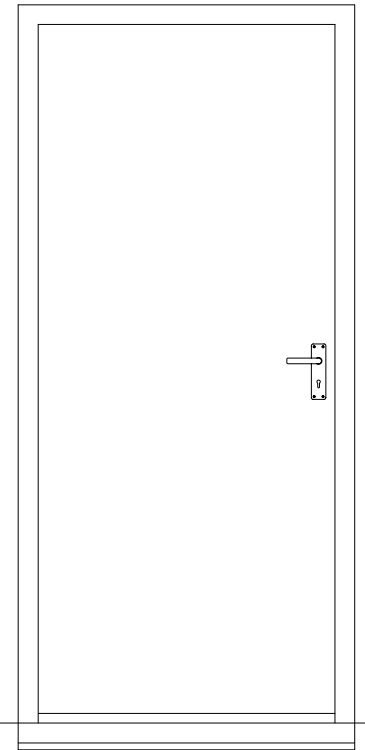

Other colours available on request
Reference for these colours at the end of the document

Door Type Colour Wall Thickness
 Cust Ref Inside Outside Frame mm
 Part Number: 4 0 2 - -

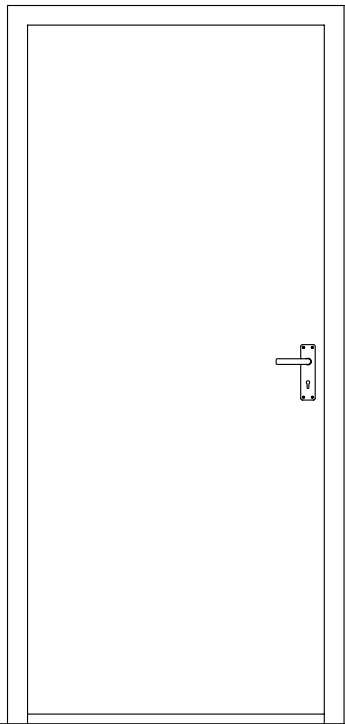

Right Hand Outward Opening - Plain
Inside View

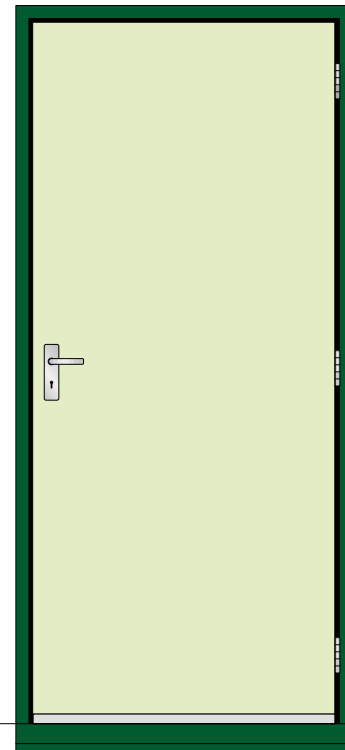
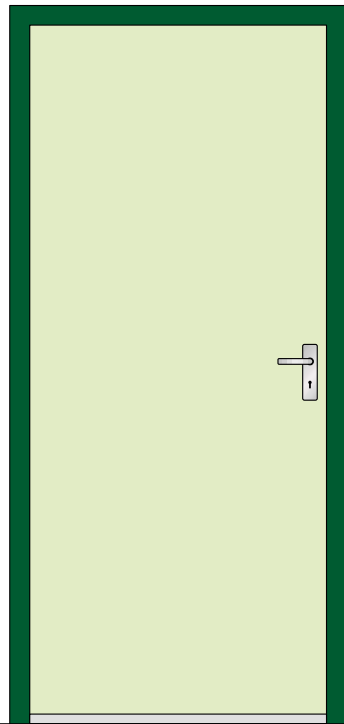

Right Hand Outward Opening - Plain
Outside View

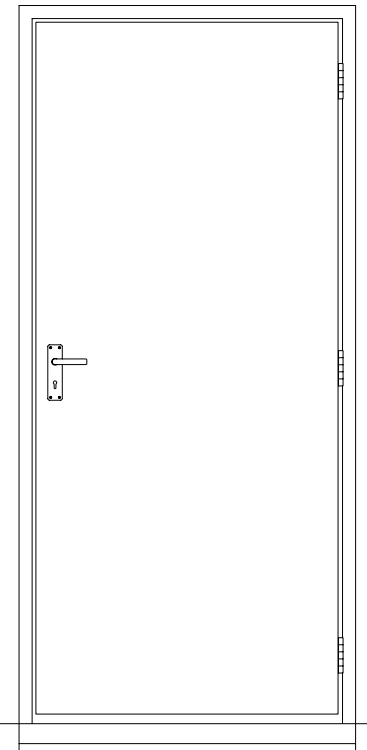

Other colours available on request
Reference for these colours at the end of the document

Door Type Colour Wall Thickness
 Cust Ref Inside Outside Frame mm
 Part Number: 4 0 3 - -



Left Hand Outward Opening - Plain
Inside View

Left Hand Outward Opening - Plain
Outside View



Other colours available on request
Reference for these colours at the end of the document

Door Type Colour Wall Thickness
 Cust Ref Inside Outside Frame mm
 Part Number: 4 0 4 - -

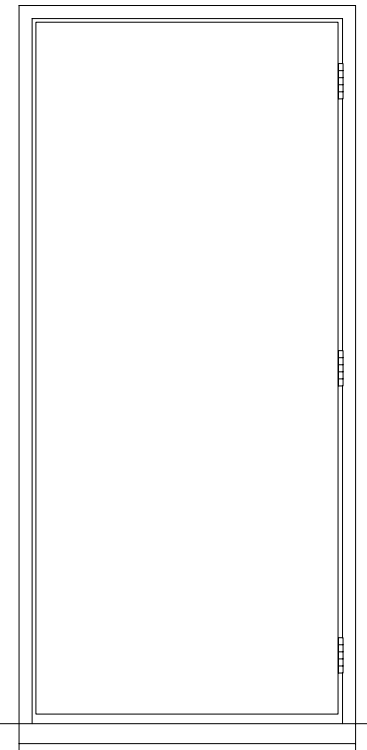
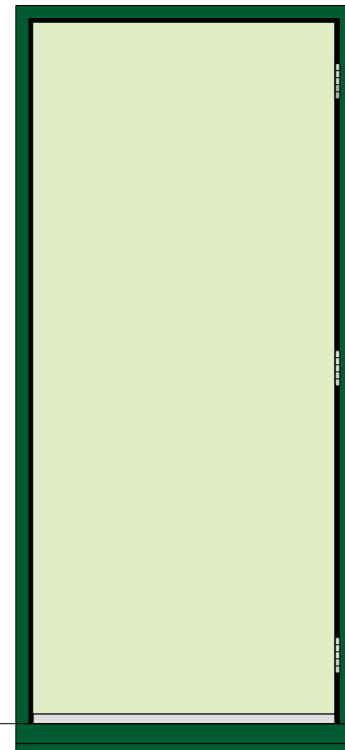
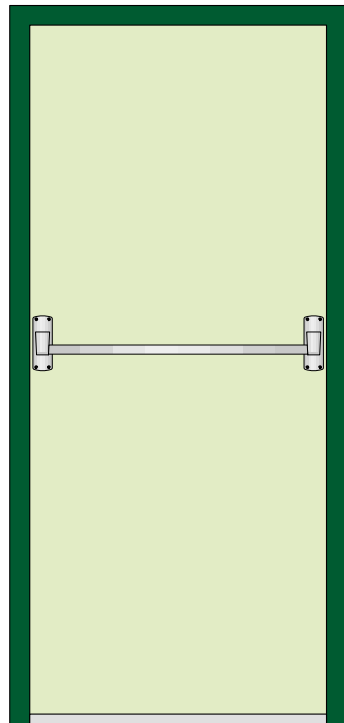
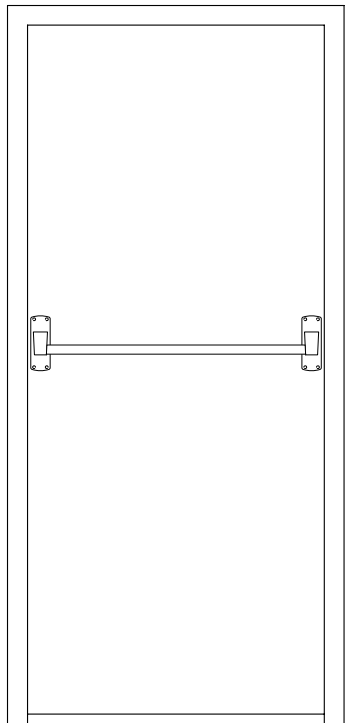

Right Hand Outward Opening - Plain Emergency Exit
Inside View

Right Hand Outward Opening - Plain Emergency Exit
Outside View



Other colours available on request
Reference for these colours at the end of the document

Door Type Colour Wall Thickness
 Cust Ref Inside Outside Frame mm
 Part Number: 4 0 5 - -

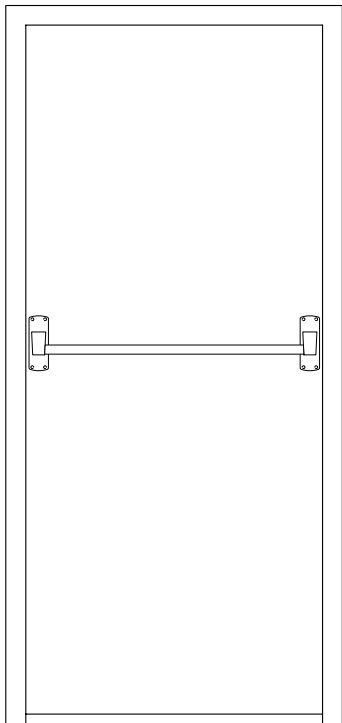

Left Hand Outward Opening - Plain Emergency Exit
Inside View

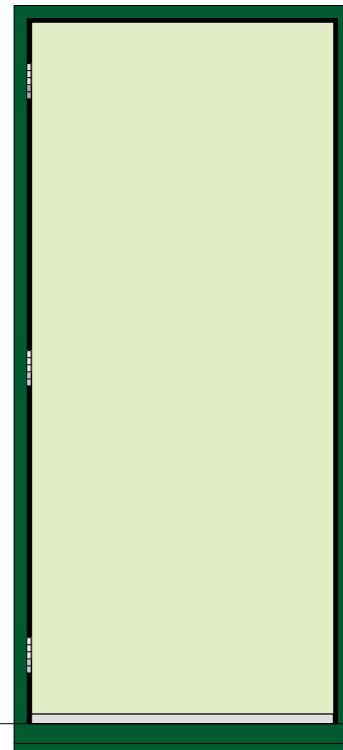
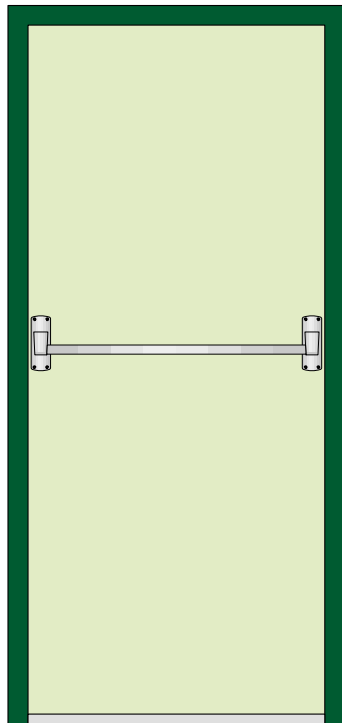

Left Hand Outward Opening - Plain Emergency Exit
Outside View

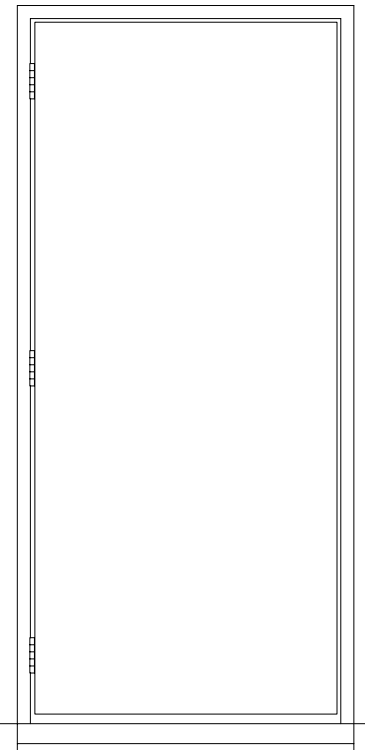

Other colours available on request
Reference for these colours at the end of the document

Door Type Colour Wall Thickness
 Cust Ref Inside Outside Frame mm

Part Number: 4 0 6 - -

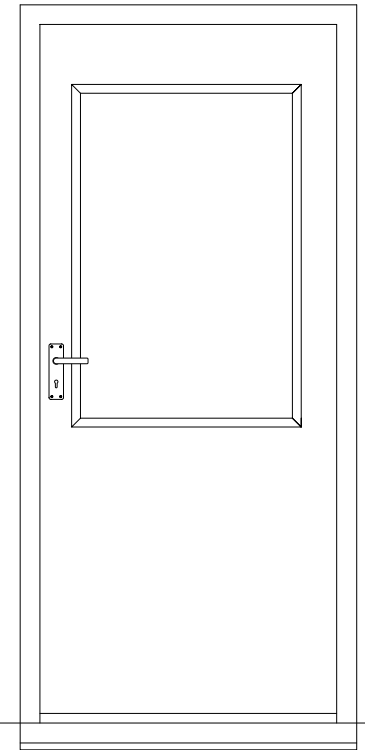
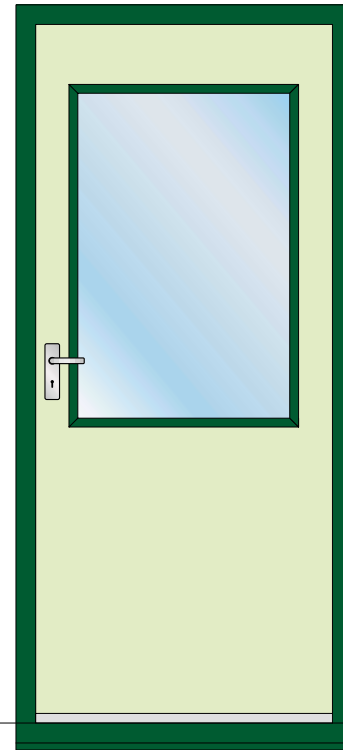
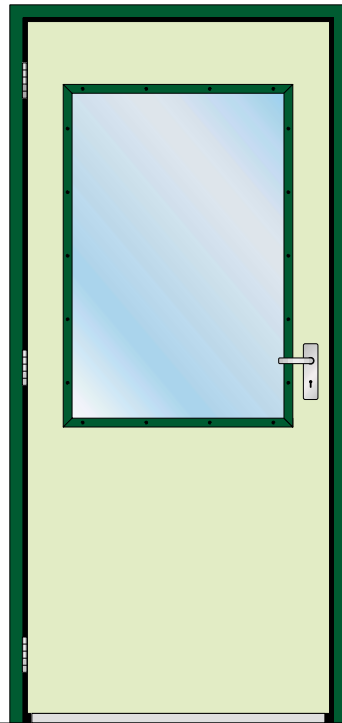
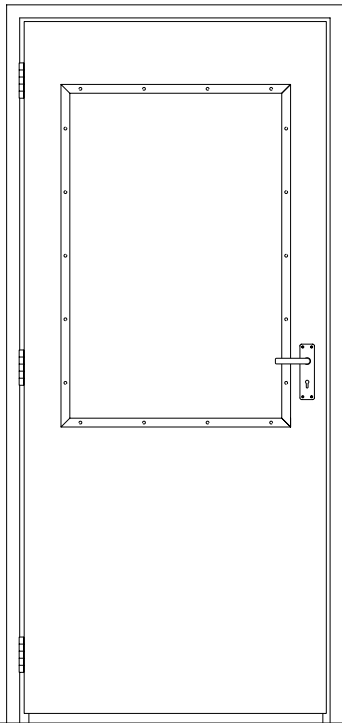

Right Hand Inward Opening - Glazed
 Inside View

Right Hand Inward Opening - Glazed
 Outside View



Other colours available on request
 Reference for these colours at the end of the document

Door Type Colour Wall Thickness
 Cust Ref Inside Outside Frame mm
 Part Number: 4 0 7 - -

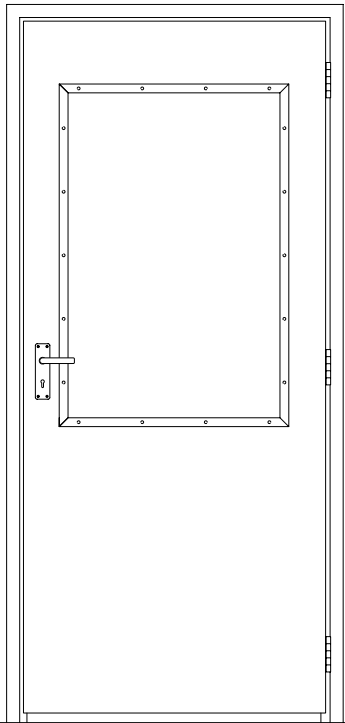

Left Hand Inward Opening - Glazed
Inside View

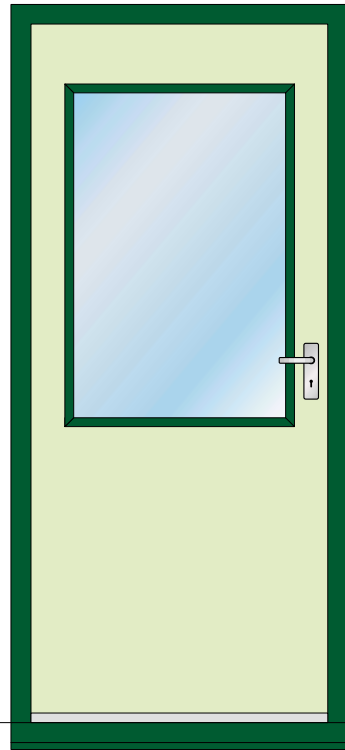
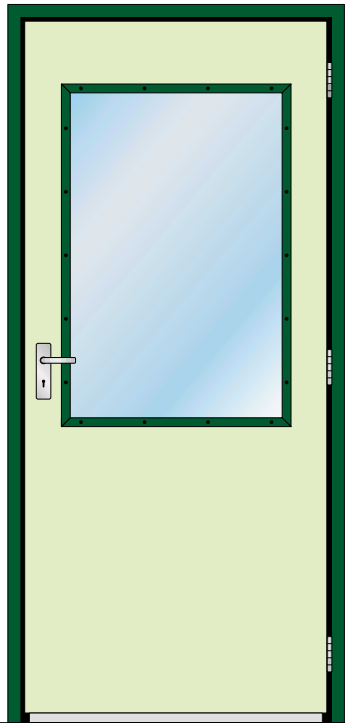

Left Hand Inward Opening - Glazed
Outside View

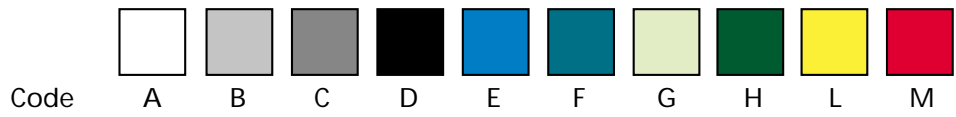
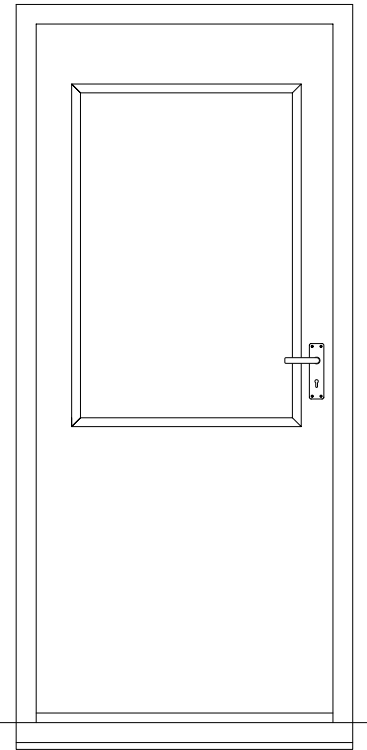

Other colours available on request
Reference for these colours at the end of the document

Door Type Colour Wall Thickness
 Cust Ref Inside Outside Frame mm
 Part Number: 4 0 8 - -

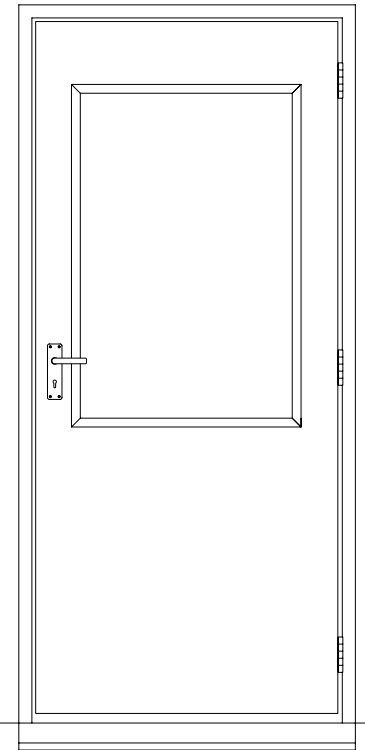
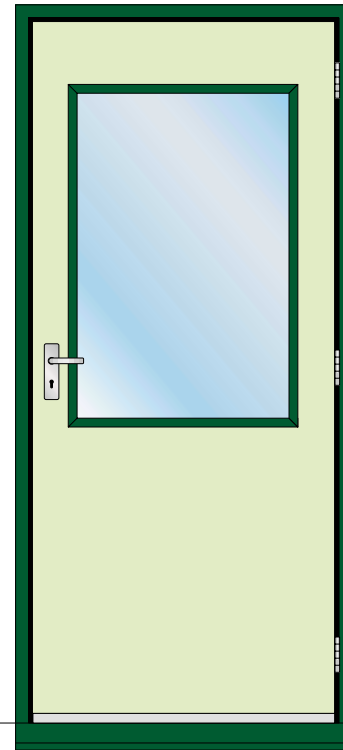
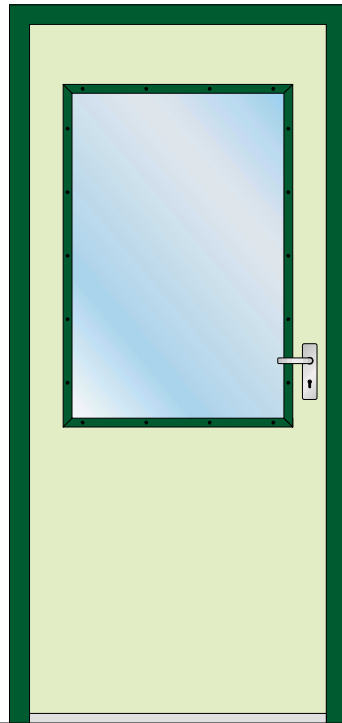
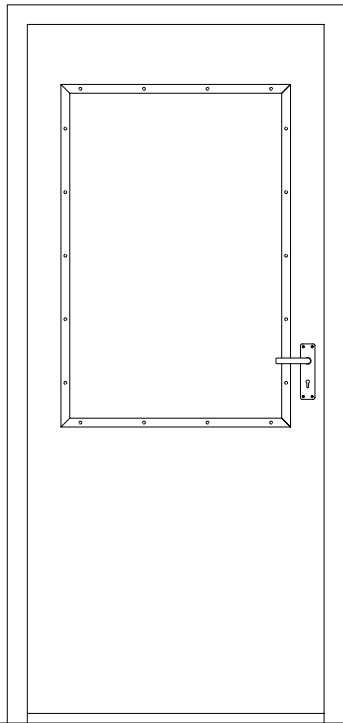

Right Hand Outward Opening - Glazed
Inside View

Right Hand Outward Opening - Glazed
Outside View

	<input type="checkbox"/>	<input type="checkbox"/>	<input type="checkbox"/>	<input type="checkbox"/>	<input type="checkbox"/>	<input type="checkbox"/>	<input type="checkbox"/>	<input type="checkbox"/>	<input type="checkbox"/>	<input type="checkbox"/>
Code	A	B	C	D	E	F	G	H	L	M

Other colours available on request
Reference for these colours at the end of the document

Door Type Colour Wall Thickness
 Cust Ref Inside Outside Frame mm

Part Number: 4 0 9 - -

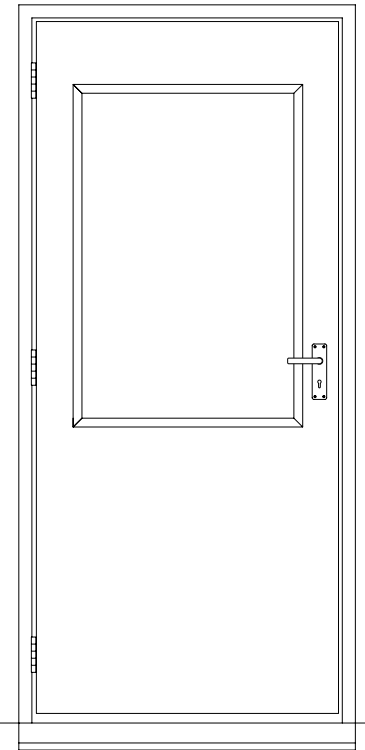
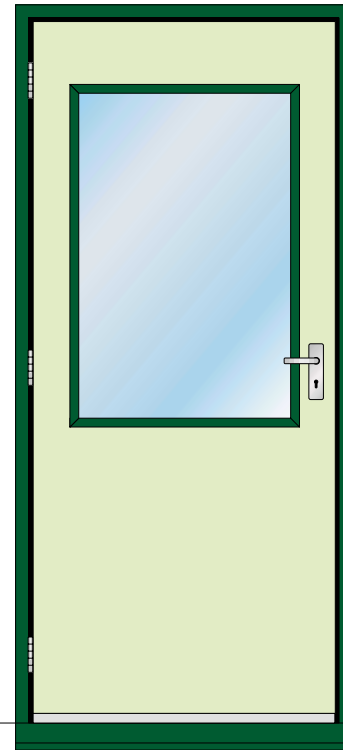
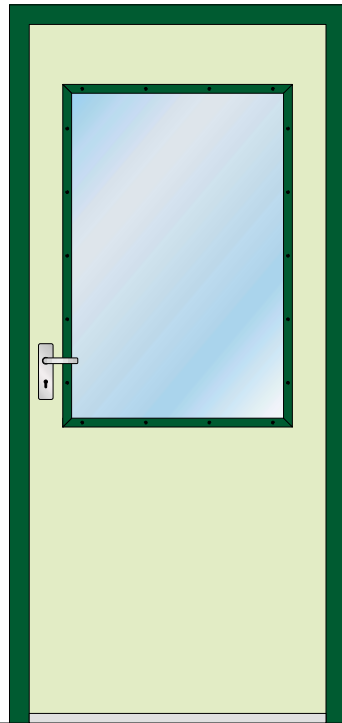
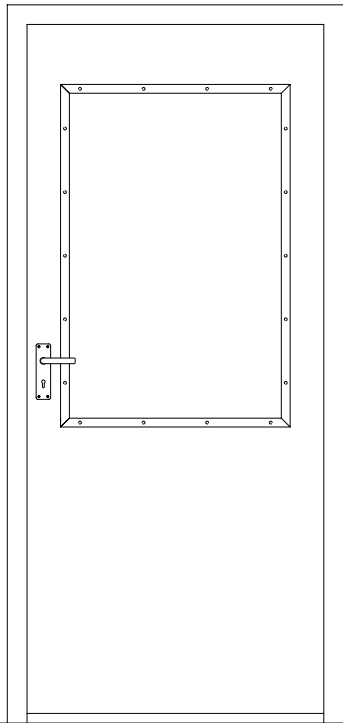

Left Hand Outward Opening - Glazed
 Inside View

Left Hand Outward Opening - Glazed
 Outside View



Other colours available on request
 Reference for these colours at the end of the document

Door Type Colour Wall Thickness
 Cust Ref Inside Outside Frame mm
 Part Number: 4 1 0 - -

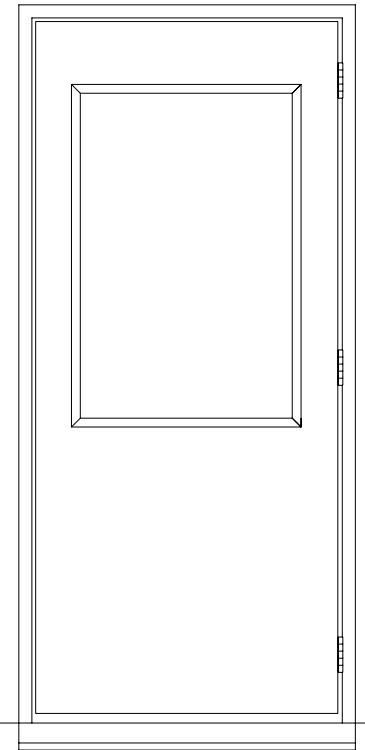
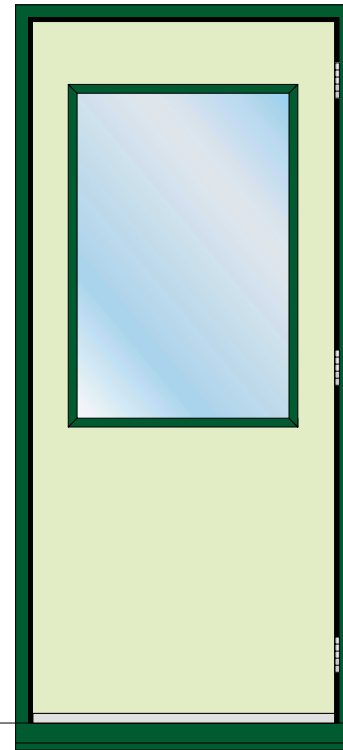
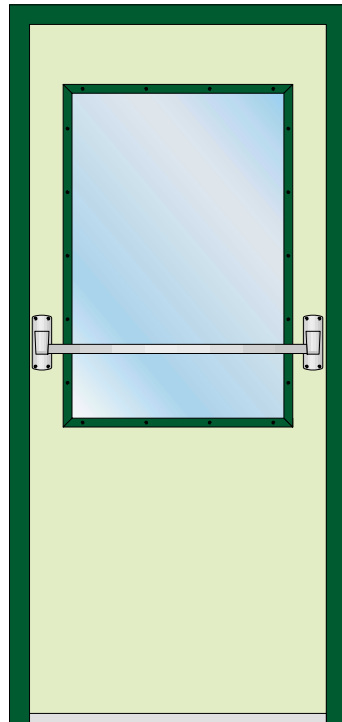
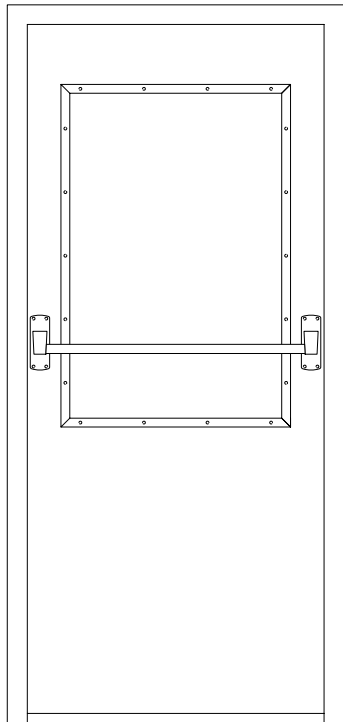

Right Hand Outward Opening - Glazed Emergency Exit
Inside View

Right Hand Outward Opening - Glazed Emergency Exit
Outside View



Other colours available on request
Reference for these colours at the end of the document

Door Type Colour Wall Thickness
 Cust Ref Inside Outside Frame mm
 Part Number: 4 1 1 - -

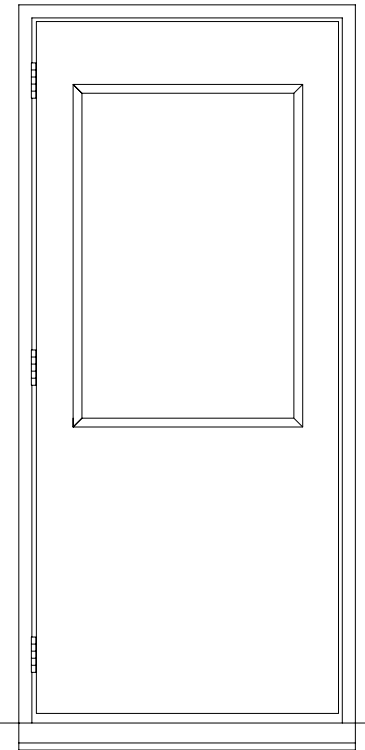
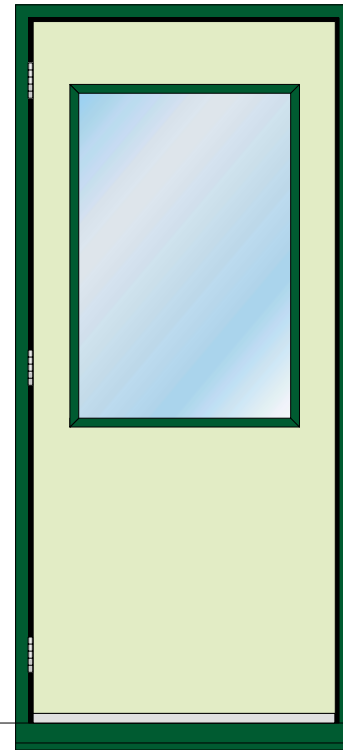
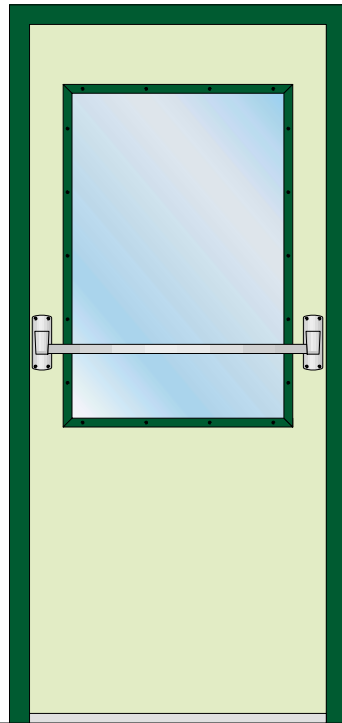
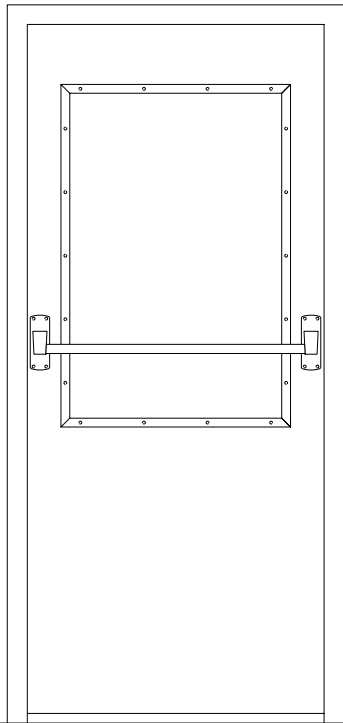

Left Hand Outward Opening - Glazed Emergency Exit
Inside View

Left Hand Outward Opening - Glazed Emergency Exit
Outside View



Other colours available on request
Reference for these colours at the end of the document

Door Type Colour Wall Thickness
 Cust Ref Inside Outside Frame mm
 Part Number: 4 1 2 - -

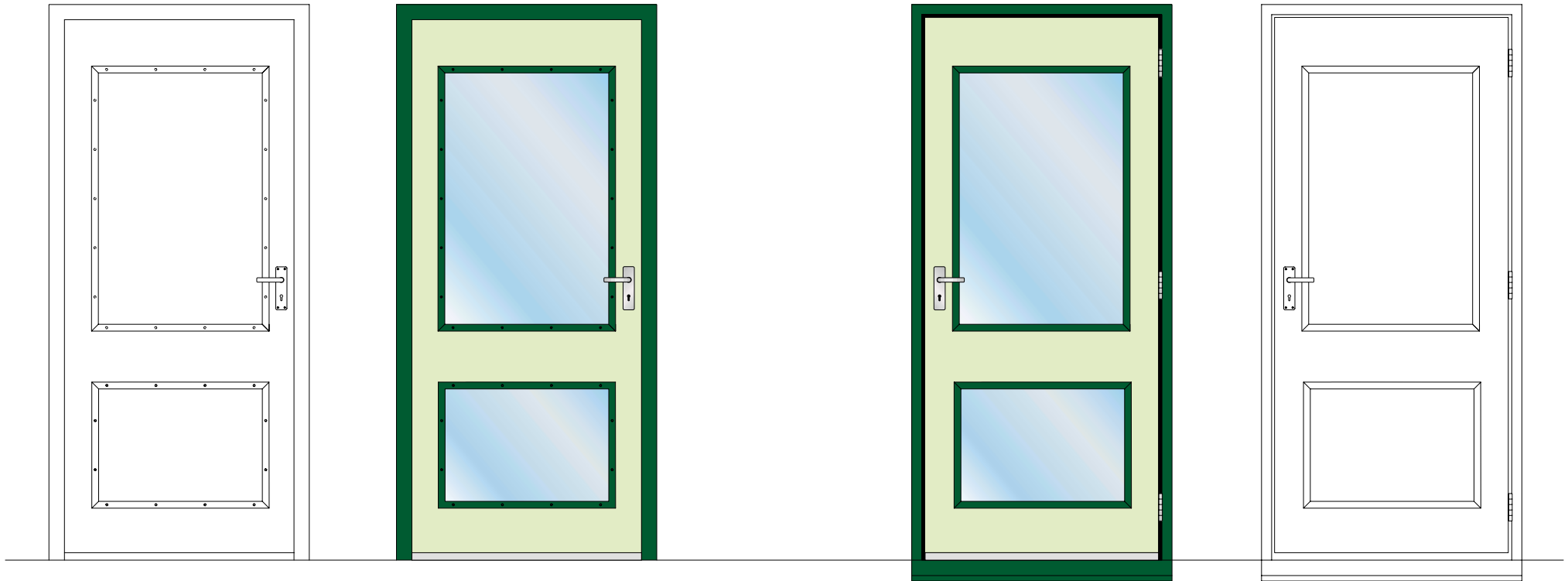

Right Hand Inward Opening - Fully Glazed
Inside View

Right Hand Inward Opening - Fully Glazed
Outside View



Other colours available on request
Reference for these colours at the end of the document

Door Type Colour Wall Thickness
 Cust Ref Inside Outside Frame mm
 Part Number: 4 1 3 - -

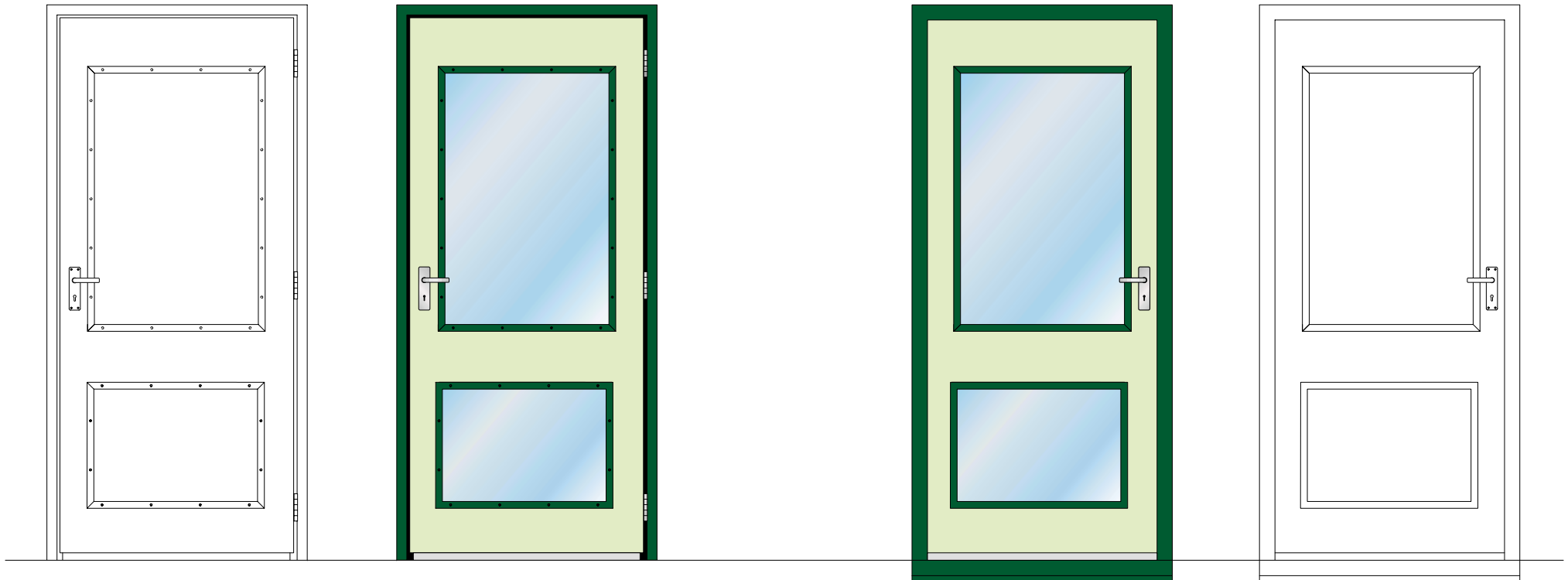

Left Hand Inward Opening - Fully Glazed
Inside View

Left Hand Inward Opening - Fully Glazed
Outside View



Other colours available on request
Reference for these colours at the end of the document

Door Type Colour Wall Thickness
 Cust Ref Inside Outside Frame mm

Part Number: 4 1 4 - -

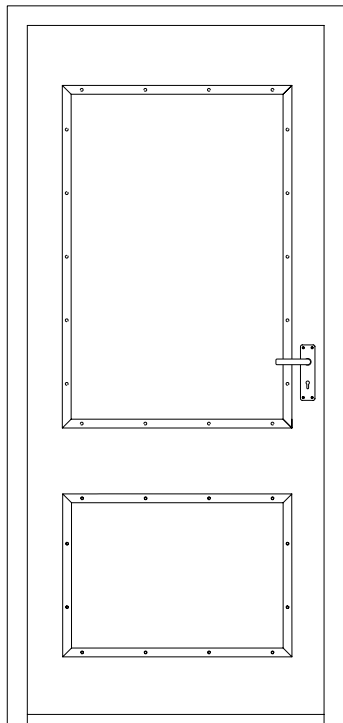

Right Hand Outward Opening - Fully Glazed
 Inside View

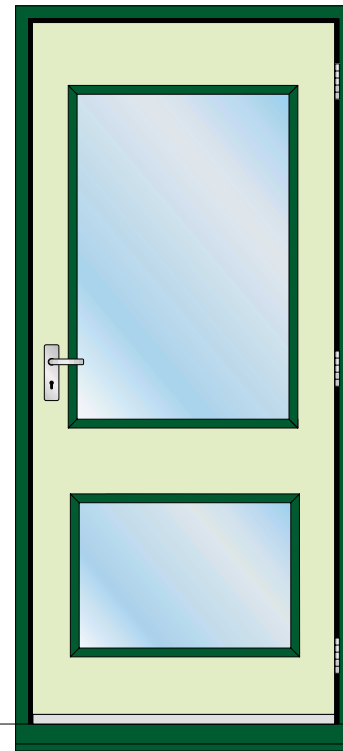
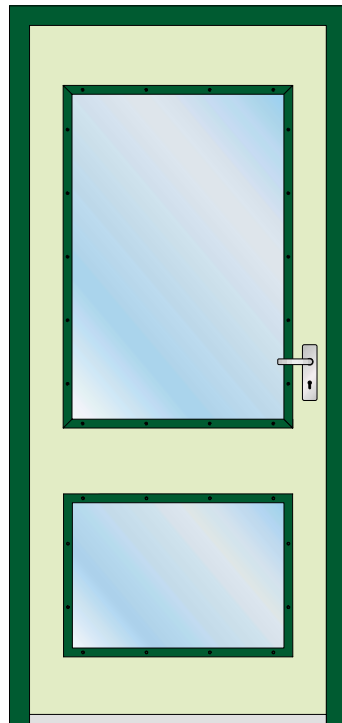

Right Hand Outward Opening - Fully Glazed
 Outside View

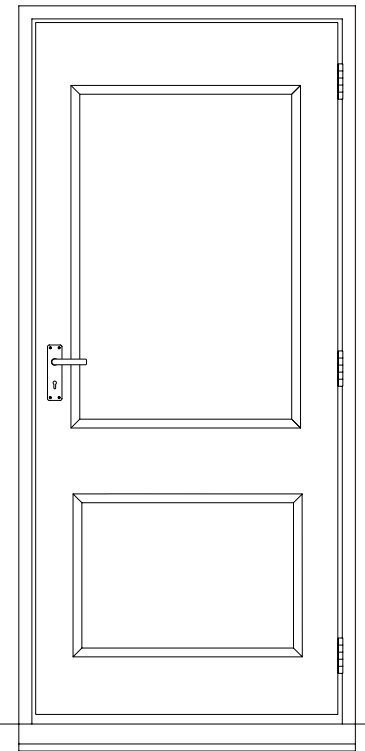

Other colours available on request
 Reference for these colours at the end of the document

Door Type Colour Wall Thickness
 Cust Ref Inside Outside Frame mm

Part Number: 4 1 5 - -

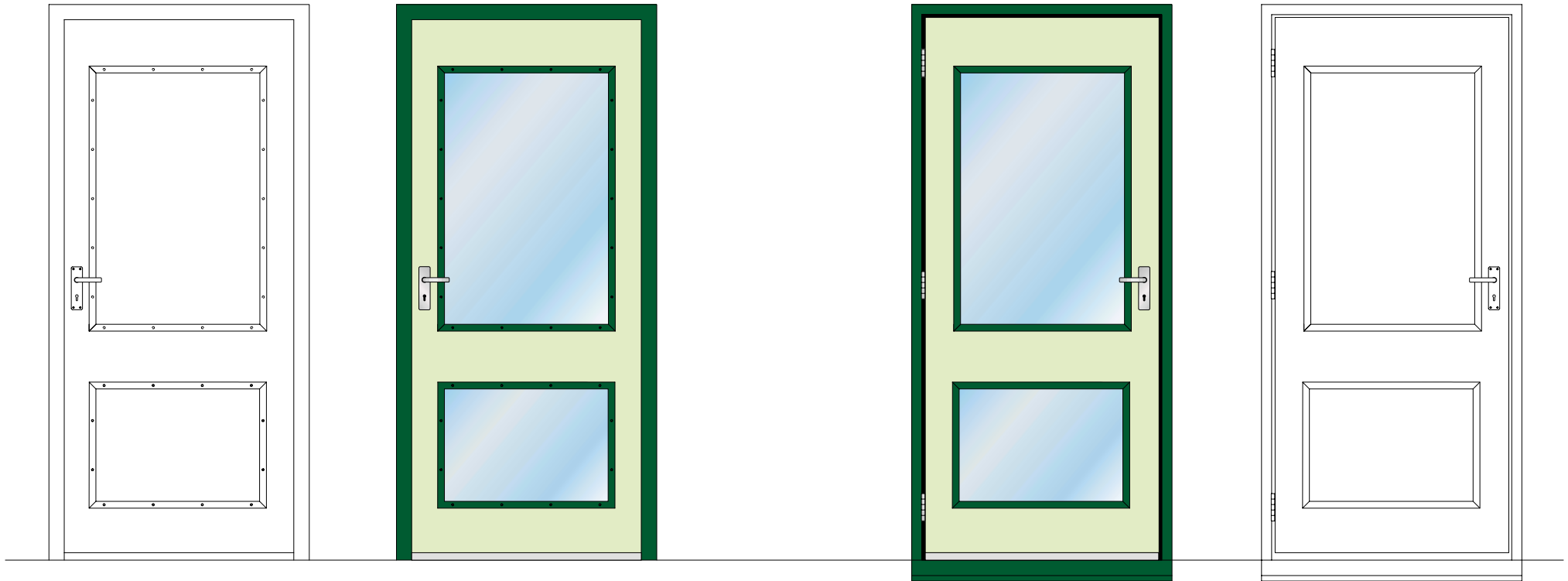

Left Hand Outward Opening - Fully Glazed
 Inside View

Left Hand Outward Opening - Fully Glazed
 Outside View



Other colours available on request
 Reference for these colours at the end of the document

Door Type Colour Wall Thickness
 Cust Ref Inside Outside Frame mm
 Part Number: 4 1 6 - -

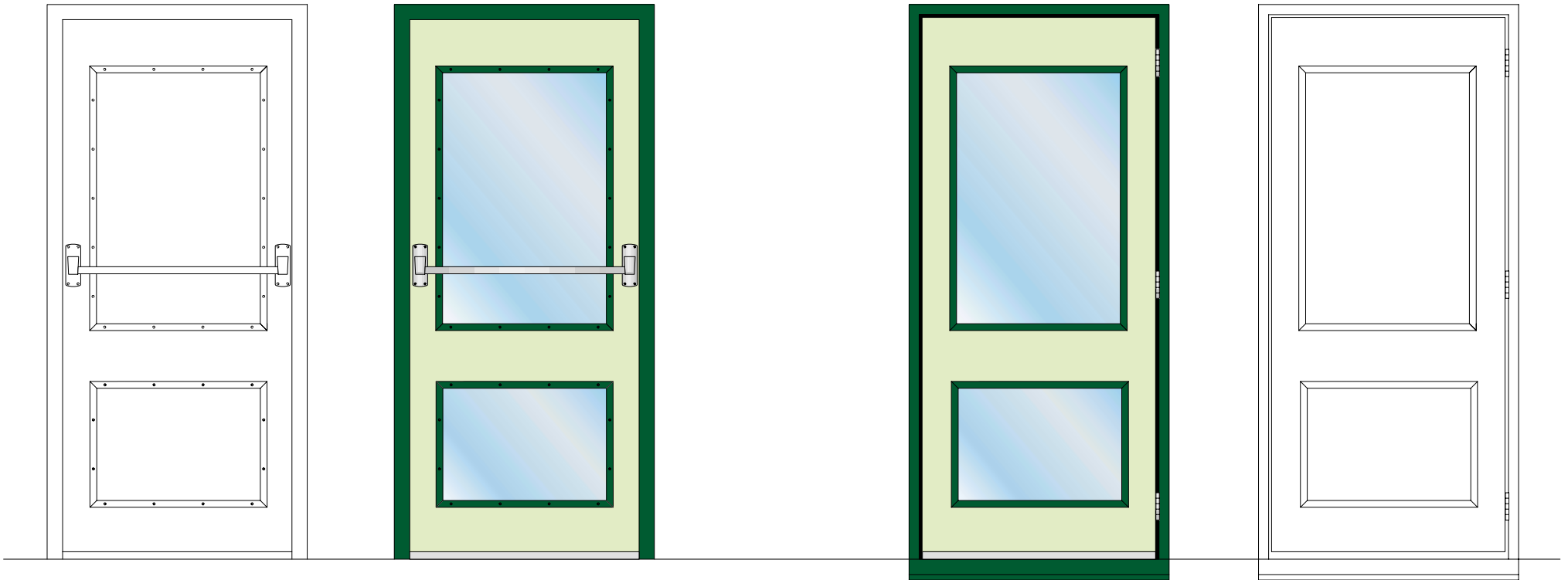

Right Hand Outward Opening - Fully Glazed Emergency Exit
Inside View

Right Hand Outward Opening - Fully Glazed Emergency Exit
Outside View



Other colours available on request
Reference for these colours at the end of the document

Door Type Colour Wall Thickness
 Cust Ref Inside Outside Frame mm
 Part Number: 4 1 7 - -

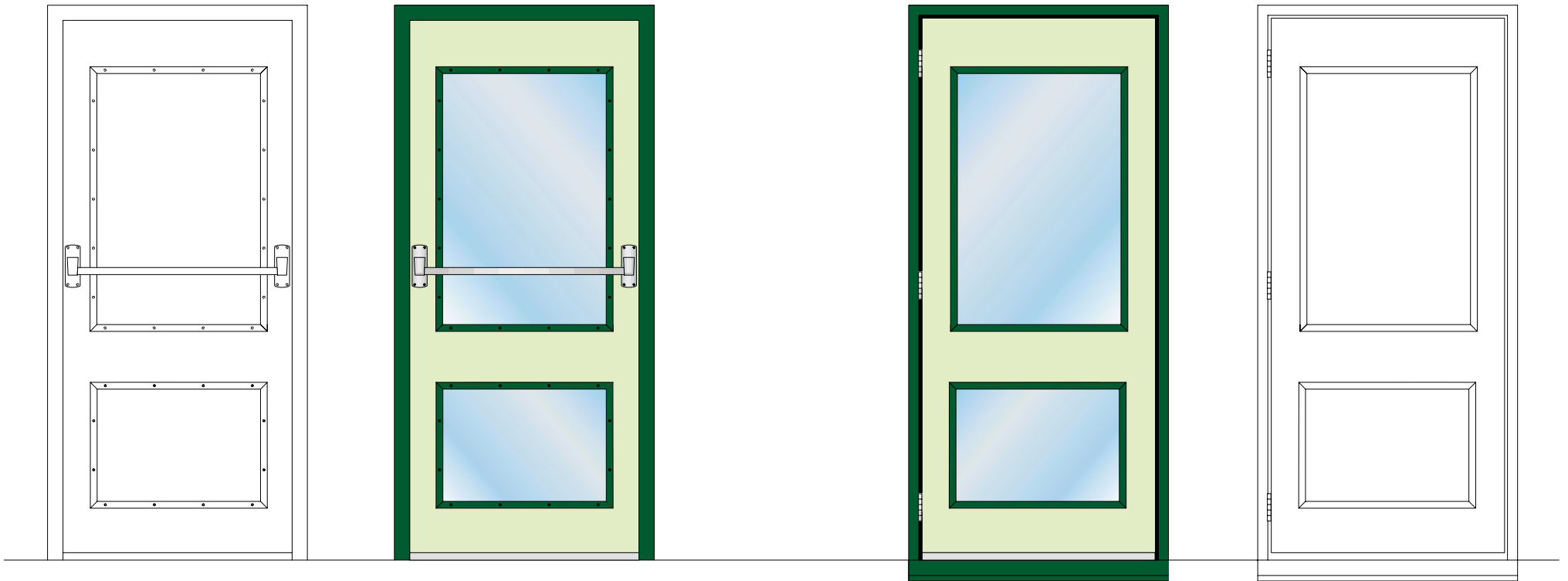

Left Hand Outward Opening - Fully Glazed Emergency Exit
Inside View

Left Hand Outward Opening - Fully Glazed Emergency Exit
Outside View



Other colours available on request
Reference for these colours at the end of the document

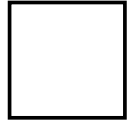

A White

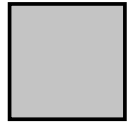

B Goosewing Grey

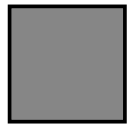

C Merlin Grey



D Black



E Solent Blue



F Olive Green



G Aztec Yellow



H Ocean Blue



L Moorland Green



M Poppy Red

Other colours available on request